

Roupeiro Kids 5 portas 2 gavetas

Dimensões: Alt. 2,02 - Larg. 1,22 - Prof. 0,46

K152 - Rosa / Branco
K252 - Violeta / Branco
K352 - Branco
K552 - Azul / Branco
KF 752 - Pink Floral / Branco











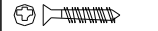
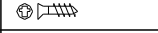
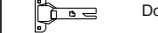
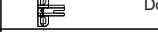

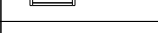

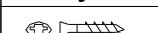

Dicas do fabricante:

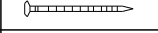
A - Separe e identifique as peças de acordo com o manual de montagem.

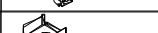
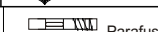
B - Monte o roupeiro no chão, em cima do papelão e com a frente para baixo.

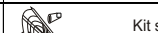
C - Não se esqueça de colocar as buchas nos sóculos e rodapés, isso garantirá maior firmeza ao roupeiro.

E - Não se esqueça, o esquadro do móvel depende da boa colocação do fundo.

	Ferragem	Qtd.
A	Tapafuro 8mm	18
B	 4,0x40	24
C	 4,0x30	14
D	 3,5x14	100
E	Bucha plástica	12
F	 Dobradiça	14
G	 Dobradiça	14
H	 6x30	04
I	 8x30	02
J	 8x40	02
K	 Puxador	07
L		02
M	 4,0x20	02
N	 L - Metal	02
O	 Pino	12
P	 10x10	65
Q	 13x15	14
R		10
S	 Corrediça	02
T	 Suporte	03
U	 15mm	06
V	 Parafuso mini-fix	08
X	 Tambor mini-fix	08
Z	 Kit sapateira	01
&	 Limitador sapateira	01
	Tapafuro mini-fix	10
	Cola	01

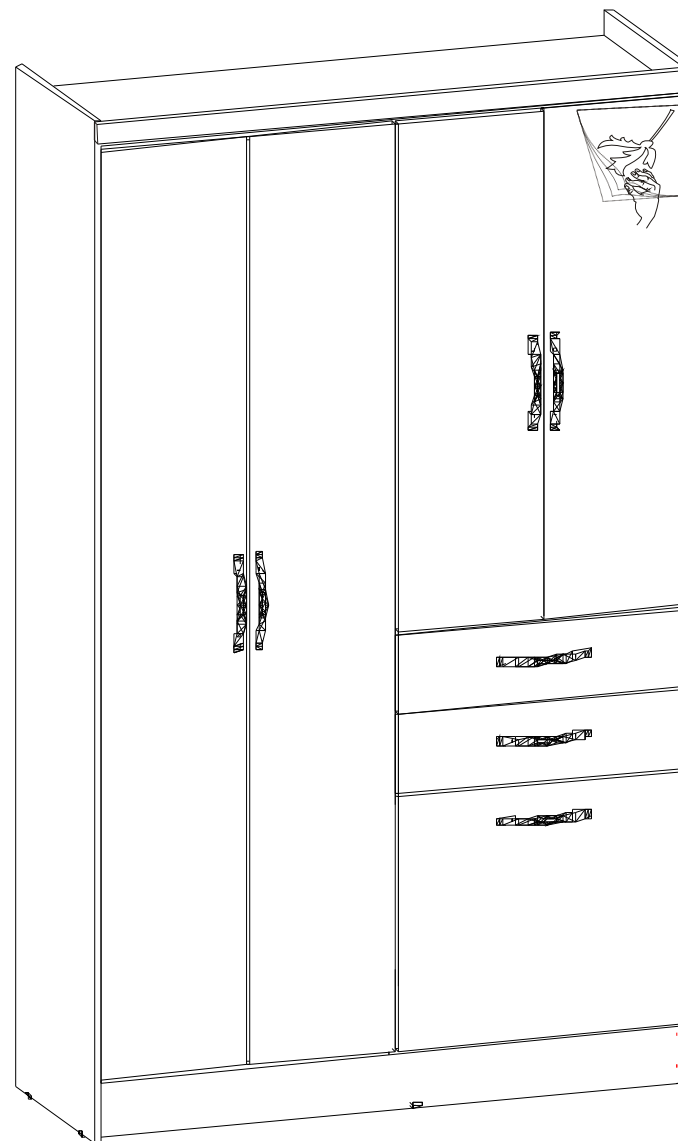

1º Passo

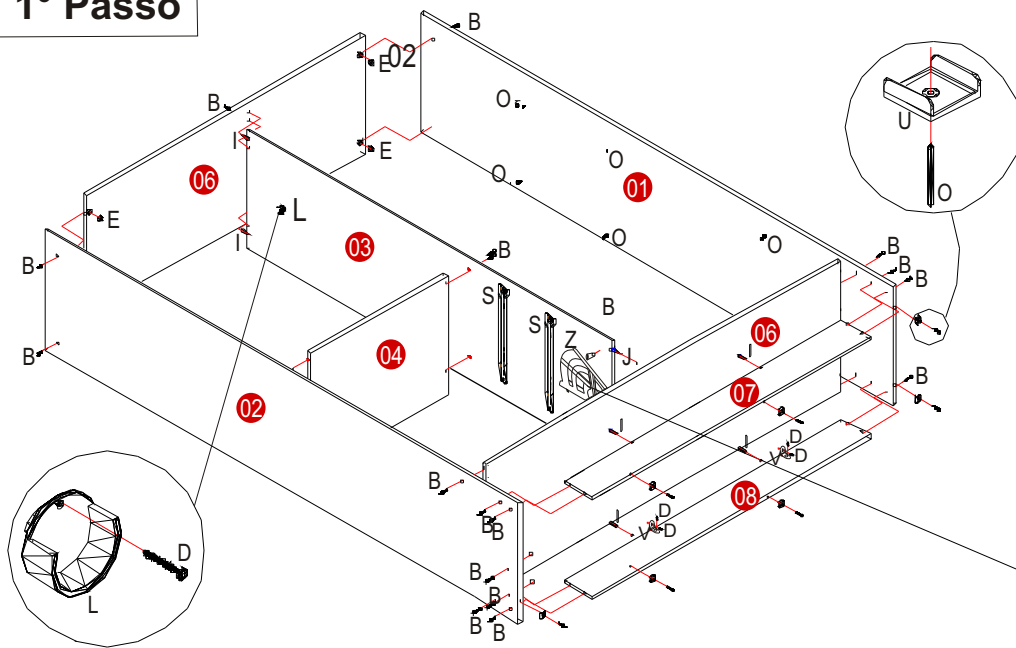

2º Passo

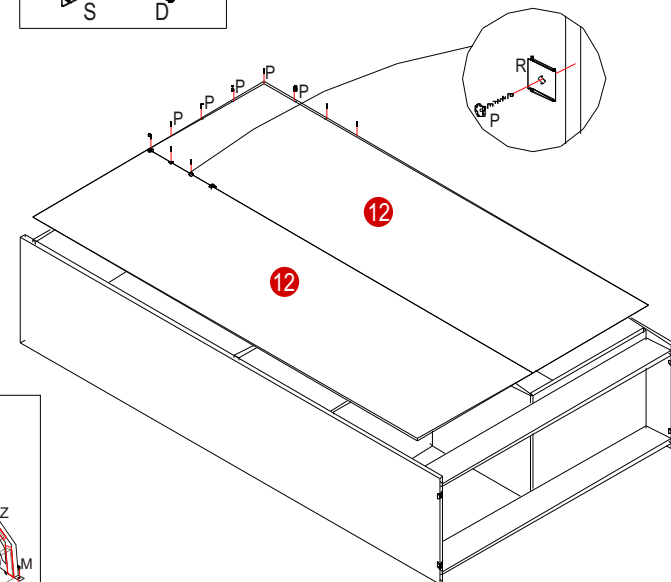
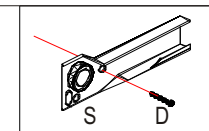
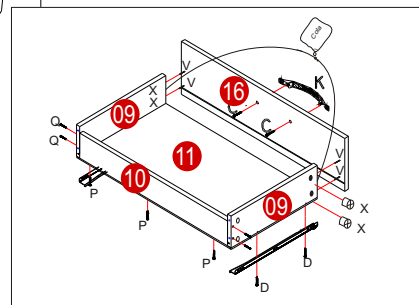

DETALHE SAPATEIRA

Os suportes 18 e 19 deverão ser parafusados com parafuso 3.5x14 na guia plástica lateral antes da mesma ser fixada na frente da sapateira

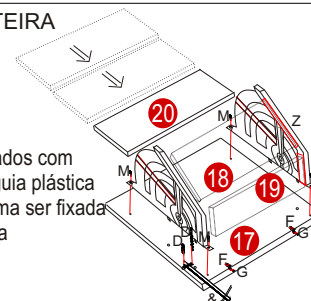

3º Passo

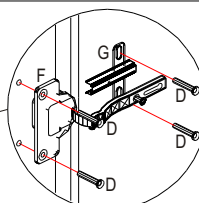
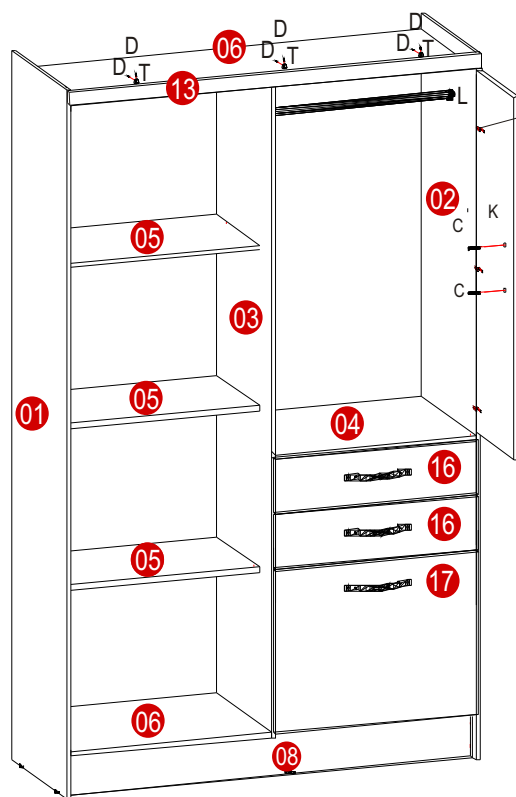

Dobradiça

Relação de peças:

- 01 - Lateral esquerda
- 02 - Lateral direita
- 03 - Divisória
- 04 - Prateleira Maior
- 05 - Prateleira recuada
- 06 - Sóculos
- 07 - Rodapé traseiro
- 08 - Rodapé frontal
- 09 - Lateral de gaveta
- 10 - Traseira de gaveta

Etapas de colagem do adesivo:

- 01 - Limpe bem o local removendo as impurezas.
- 03 - Remova o papel que protege o adesivo deixando somente a máscara transparente.
- 04 - Posicione e cole o adesivo no lado direito do roupeiro conforme a imagem friccionando sobre ele para não deixar bolhas.
- 05 - Levemente e devagar remova a máscara transparente deixando no local somente o adesivo.

Relação de peças

- 11 - Fundo de gaveta
- 12 - Costa de roupeiro
- 13 - Rodaforro
- 14 - Porta maior
- 15 - Porta menos
- 16 - Frente de gaveta
- 17 - Porta sapateira
- 18 - Prateleira média sapateira
- 19 - Prateleira menor sapateira
- 20 - Prateleira maior sapateira

